

# NCV8440

## Protected Power MOSFET

2.6 A, 52 V, N-Channel, Logic Level, Clamped MOSFET w/ ESD Protection

### Benefits

- High Energy Capability for Inductive Loads
- Low Switching Noise Generation

### Features

- Diode Clamp Between Gate and Source
- ESD Protection – HBM 5000 V
- Active Over-Voltage Gate to Drain Clamp
- Scalable to Lower or Higher  $R_{DS(on)}$
- Internal Series Gate Resistance
- These are Pb-Free Devices

### Applications

- Automotive and Industrial Markets:  
Solenoid Drivers, Lamp Drivers, Small Motor Drivers
- NCV Prefix for Automotive and Other Applications Requiring Site and Control Changes



ON Semiconductor®

<http://onsemi.com>

$V_{DSS}$ (Clamped)	$R_{DS(on)}$ TYP	$I_D$ MAX
52 V	95 mΩ @ 10 V	2.6 A

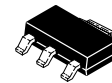
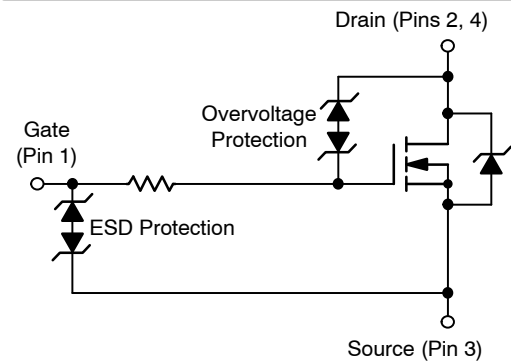

SOT-223  
CASE 318E  
STYLE 3

- 1 = Gate
- 2 = Drain
- 3 = Source

### MARKING DIAGRAM

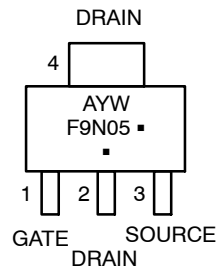

- A = Assembly Location
- Y = Year
- W = Work Week
- = Pb-Free Package

(Note: Microdot may be in either location)

### ORDERING INFORMATION

Device	Package	Shipping†
NCV8440STT1G	SOT-223 (Pb-Free)	1000/Tape & Reel
NCV8440STT3G	SOT-223 (Pb-Free)	4000/Tape & Reel

†For information on tape and reel specifications, including part orientation and tape sizes, please refer to our Tape and Reel Packaging Specification Brochure, BRD8011/D.

# NCV8440

## MAXIMUM RATINGS ( $T_J = 25^\circ\text{C}$ unless otherwise noted)

Rating	Symbol	Value	Unit
Drain-to-Source Voltage Internally Clamped	$V_{DSS}$	52-59	V
Gate-to-Source Voltage – Continuous	$V_{GS}$	$\pm 15$	V
Drain Current – Continuous @ $T_A = 25^\circ\text{C}$ – Single Pulse ( $t_p = 10 \mu\text{s}$ ) (Note 1)	$I_D$ $I_{DM}$	2.6 10	A
Total Power Dissipation @ $T_A = 25^\circ\text{C}$ (Note 1)	$P_D$	1.69	W
Operating and Storage Temperature Range	$T_J, T_{stg}$	-55 to 150	$^\circ\text{C}$
Single Pulse Drain-to-Source Avalanche Energy ( $V_{DD} = 50 \text{ V}$ , $I_{D(pk)} = 1.17 \text{ A}$ , $V_{GS} = 10 \text{ V}$ , $L = 160 \text{ mH}$ , $R_G = 25 \Omega$ )	$E_{AS}$	110	mJ
Load Dump Voltage ( $V_{GS} = 0$ and $10 \text{ V}$ , $R_I = 2.0 \Omega$ , $R_L = 9.0 \Omega$ , $t_d = 400 \text{ ms}$ )	$V_{LD}$	60	V
Thermal Resistance, Junction-to-Ambient (Note 1) Junction-to-Ambient (Note 2)	$R_{\theta JA}$ $R_{\theta JA}$	74 169	$^\circ\text{C/W}$
Maximum Lead Temperature for Soldering Purposes, 1/8" from Case for 10 Seconds	$T_L$	260	$^\circ\text{C}$

Stresses exceeding Maximum Ratings may damage the device. Maximum Ratings are stress ratings only. Functional operation above the Recommended Operating Conditions is not implied. Extended exposure to stresses above the Recommended Operating Conditions may affect device reliability.

1. When surface mounted to a FR4 board using 1" pad size, (Cu area 1.127 in<sup>2</sup>).
2. When surface mounted to a FR4 board using minimum recommended pad size, (Cu area 0.412 in<sup>2</sup>).

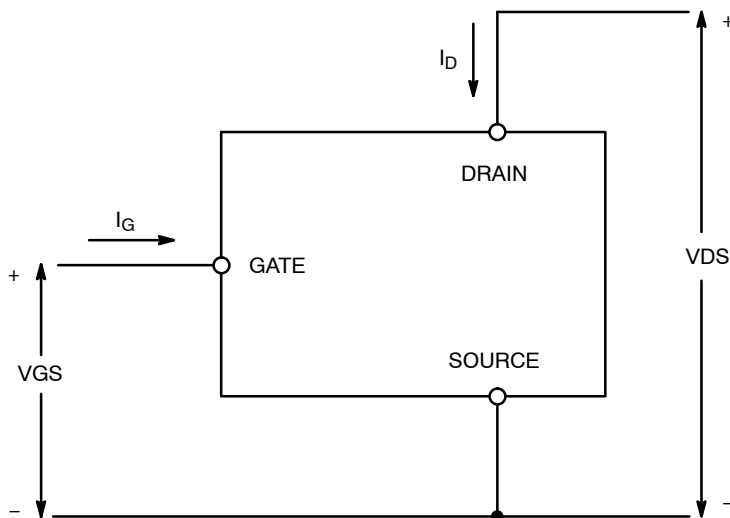

Figure 1. Voltage and Current Convention

# NCV8440

## MOSFET ELECTRICAL CHARACTERISTICS ( $T_J = 25^\circ\text{C}$ unless otherwise noted)

Characteristic	Symbol	Min	Typ	Max	Unit
----------------	--------	-----	-----	-----	------

### OFF CHARACTERISTICS

Drain-to-Source Breakdown Voltage (Note 3) ( $V_{GS} = 0\text{ V}$ , $I_D = 1.0\text{ mA}$ , $T_J = 25^\circ\text{C}$ ) ( $V_{GS} = 0\text{ V}$ , $I_D = 1.0\text{ mA}$ , $T_J = -40^\circ\text{C}$ to $125^\circ\text{C}$ ) (Note 4) Temperature Coefficient (Negative)	$V_{(BR)DSS}$	52 50.8	55 54 -9.3	59 59.5	V V mV/ $^\circ\text{C}$
Zero Gate Voltage Drain Current ( $V_{DS} = 40\text{ V}$ , $V_{GS} = 0\text{ V}$ ) ( $V_{DS} = 40\text{ V}$ , $V_{GS} = 0\text{ V}$ , $T_J = 125^\circ\text{C}$ ) (Note 4)	$I_{DSS}$			10 25	$\mu\text{A}$
Gate-Body Leakage Current ( $V_{GS} = \pm 8\text{ V}$ , $V_{DS} = 0\text{ V}$ ) ( $V_{GS} = \pm 14\text{ V}$ , $V_{DS} = 0\text{ V}$ )	$I_{GSS}$		$\pm 35$	$\pm 10$	$\mu\text{A}$

### ON CHARACTERISTICS (Note 3)

Gate Threshold Voltage (Note 3) ( $V_{DS} = V_{GS}$ , $I_D = 100\ \mu\text{A}$ ) Threshold Temperature Coefficient (Negative)	$V_{GS(th)}$	1.1	1.5 -4.1	1.9	V mV/ $^\circ\text{C}$
Static Drain-to-Source On-Resistance (Note 3) ( $V_{GS} = 3.5\text{ V}$ , $I_D = 0.6\text{ A}$ ) ( $V_{GS} = 4.0\text{ V}$ , $I_D = 1.5\text{ A}$ ) ( $V_{GS} = 10\text{ V}$ , $I_D = 2.6\text{ A}$ )	$R_{DS(on)}$		135 150 95	180 160 110	m $\Omega$
Forward Transconductance (Note 3) ( $V_{DS} = 15\text{ V}$ , $I_D = 2.6\text{ A}$ )	$g_{FS}$		3.8		Mhos

### DYNAMIC CHARACTERISTICS

Input Capacitance	$V_{DS} = 35\text{ V}$ , $V_{GS} = 0\text{ V}$ , $f = 10\text{ kHz}$	$C_{iss}$		155		$\mu\text{F}$
Output Capacitance		$C_{oss}$		60		
Transfer Capacitance		$C_{rss}$		25		
Input Capacitance	$V_{DS} = 25\text{ V}$ , $V_{GS} = 0\text{ V}$ , $f = 10\text{ kHz}$	$C_{iss}$		170		$\mu\text{F}$
Output Capacitance		$C_{oss}$		70		
Transfer Capacitance		$C_{rss}$		30		

- Pulse Test: Pulse Width  $\leq 300\ \mu\text{s}$ , Duty Cycle  $\leq 2\%$ .
- Not subject to production testing.
- Switching characteristics are independent of operating junction temperatures.

# NCV8440

## MOSFET ELECTRICAL CHARACTERISTICS ( $T_J = 25^\circ\text{C}$ unless otherwise noted)

Characteristic	Symbol	Min	Typ	Max	Unit
<b>SWITCHING CHARACTERISTICS (Note 5)</b>					
Turn-On Delay Time	$V_{GS} = 4.5\text{ V}, V_{DD} = 40\text{ V}, I_D = 2.6\text{ A}, R_D = 15.4\ \Omega$	$t_{d(on)}$		375	ns
Rise Time		$t_r$		1525	
Turn-Off Delay Time		$t_{d(off)}$		1530	
Fall Time		$t_f$		1160	
Turn-On Delay Time	$V_{GS} = 4.5\text{ V}, V_{DD} = 40\text{ V}, I_D = 1.0\text{ A}, R_D = 40\ \Omega$	$t_{d(on)}$		325	ns
Rise Time		$t_r$		1275	
Turn-Off Delay Time		$t_{d(off)}$		1860	
Fall Time		$t_f$		1150	
Turn-On Delay Time	$V_{GS} = 10\text{ V}, V_{DD} = 15\text{ V}, I_D = 2.6\text{ A}, R_D = 5.8\ \Omega$	$t_{d(on)}$		190	ns
Rise Time		$t_r$		710	
Turn-Off Delay Time		$t_{d(off)}$		2220	
Fall Time		$t_f$		1180	
Gate Charge	$V_{GS} = 4.5\text{ V}, V_{DS} = 40\text{ V}, I_D = 2.6\text{ A (Note 3)}$	$Q_T$		4.5	nC
		$Q_1$		0.9	
		$Q_2$		2.6	
Gate Charge	$V_{GS} = 4.5\text{ V}, V_{DS} = 15\text{ V}, I_D = 1.5\text{ A (Note 3)}$	$Q_T$		3.9	nC
		$Q_1$		1.0	
		$Q_2$		1.7	

## SOURCE-DRAIN DIODE CHARACTERISTICS

Forward On-Voltage	$I_S = 2.6\text{ A}, V_{GS} = 0\text{ V (Note 3)}$ $I_S = 2.6\text{ A}, V_{GS} = 0\text{ V}, T_J = 125^\circ\text{C}$	$V_{SD}$		0.81 0.66	1.5	V
Reverse Recovery Time	$I_S = 1.5\text{ A}, V_{GS} = 0\text{ V}, di_S/dt = 100\text{ A}/\mu\text{s (Note 3)}$	$t_{rr}$		730	ns	
		$t_a$		200		
		$t_b$		530		
Reverse Recovery Stored Charge		$Q_{RR}$		6.3		$\mu\text{C}$

## ESD CHARACTERISTICS (Note 4)

Electro-Static Discharge Capability	Human Body Model (HBM)	ESD	5000			V
	Machine Model (MM)		500			

- Pulse Test: Pulse Width  $\leq 300\ \mu\text{s}$ , Duty Cycle  $\leq 2\%$ .
- Not subject to production testing.
- Switching characteristics are independent of operating junction temperatures.

TYPICAL PERFORMANCE CURVES

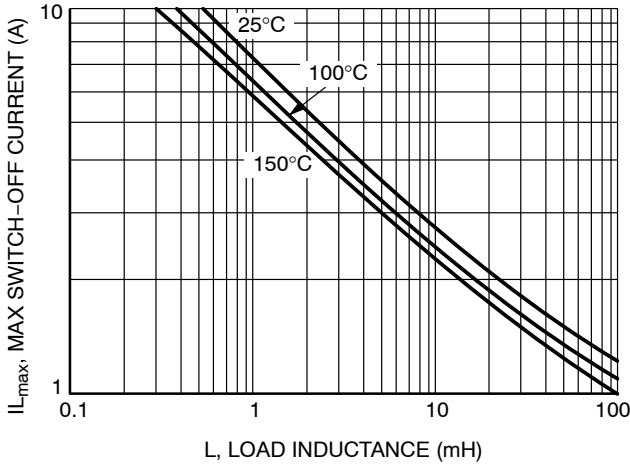

Figure 1. Single Pulse Maximum Switch-off Current vs. Load Inductance

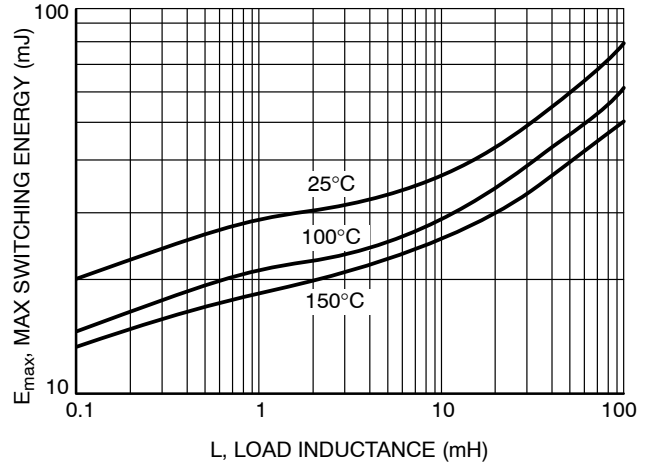

Figure 2. Single Pulse Maximum Switching Energy vs. Load Inductance

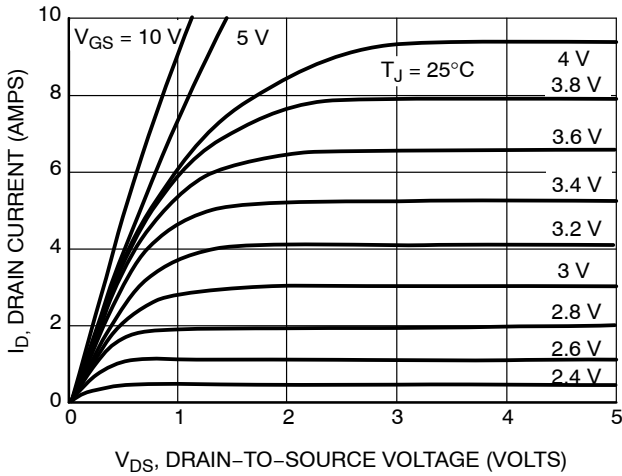

Figure 3. On-State Output Characteristics

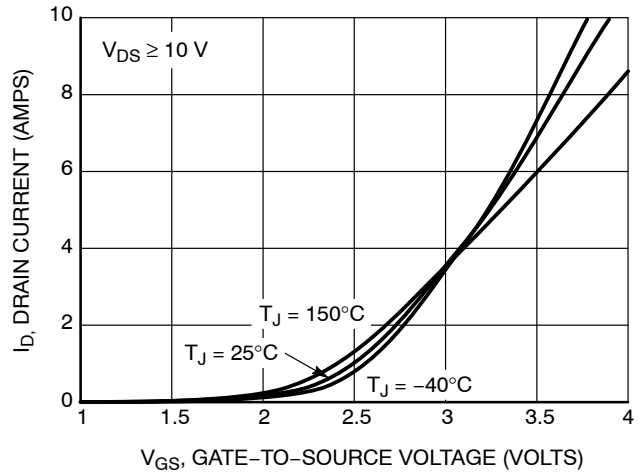

Figure 4. Transfer Characteristics

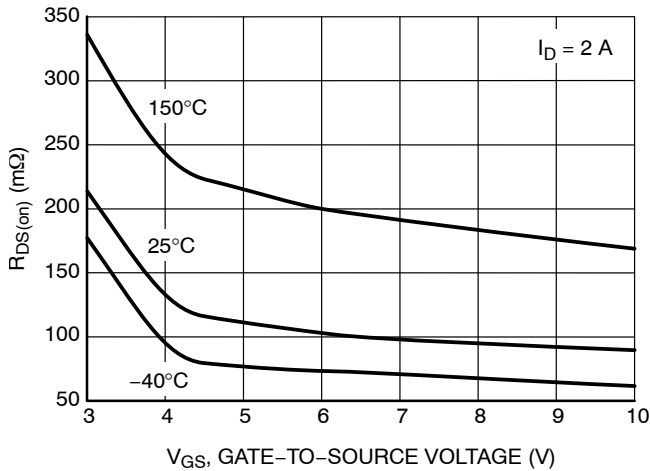

Figure 5.  $R_{DS(on)}$  vs. Gate-Source Voltage

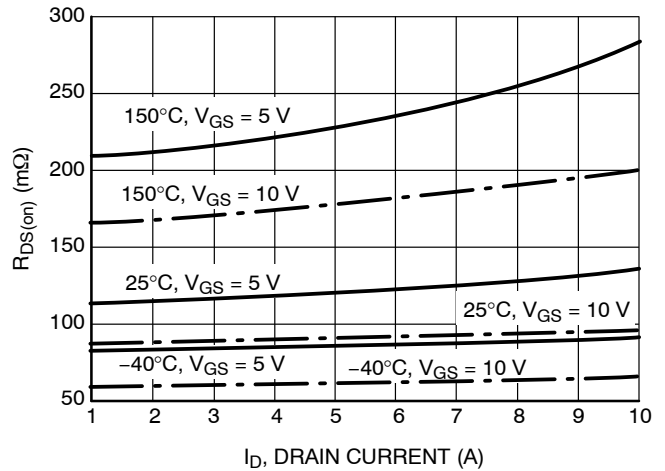

Figure 6.  $R_{DS(on)}$  vs. Drain Current

TYPICAL PERFORMANCE CURVES

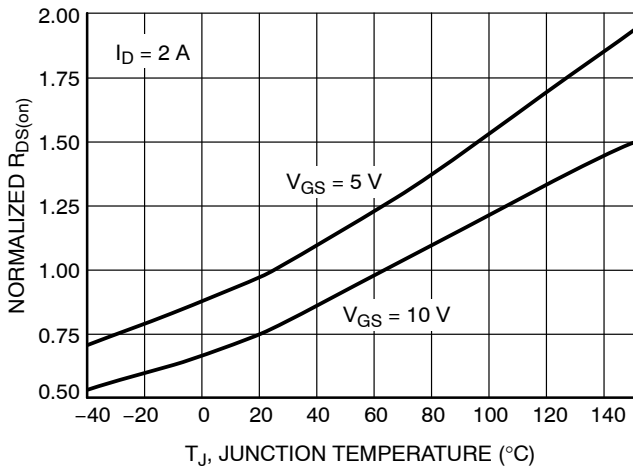

Figure 7. Normalized  $R_{DS(on)}$  vs. Temperature

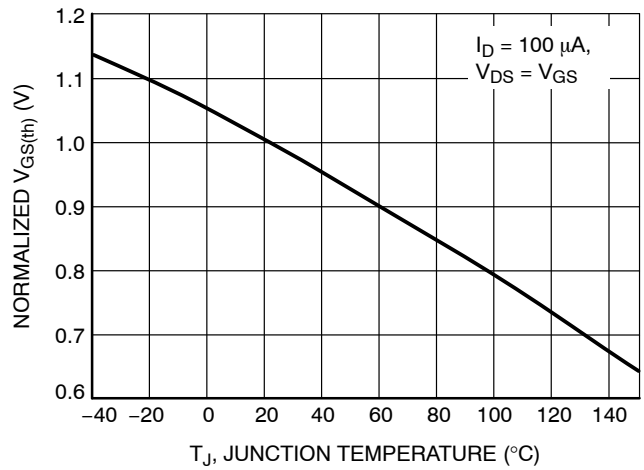

Figure 8. Normalized Threshold Voltage vs. Temperature

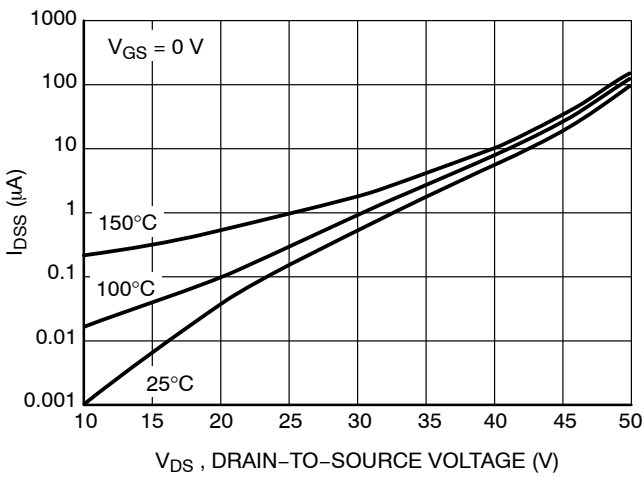

Figure 9. Drain-to-Source Leakage Current

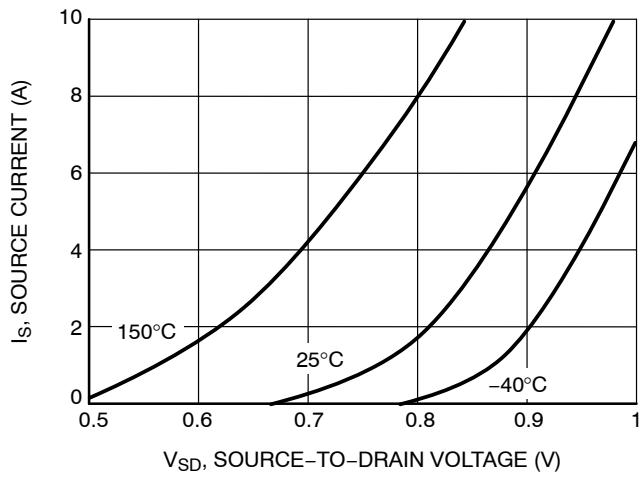

Figure 10. Source-Drain Diode Forward Characteristics

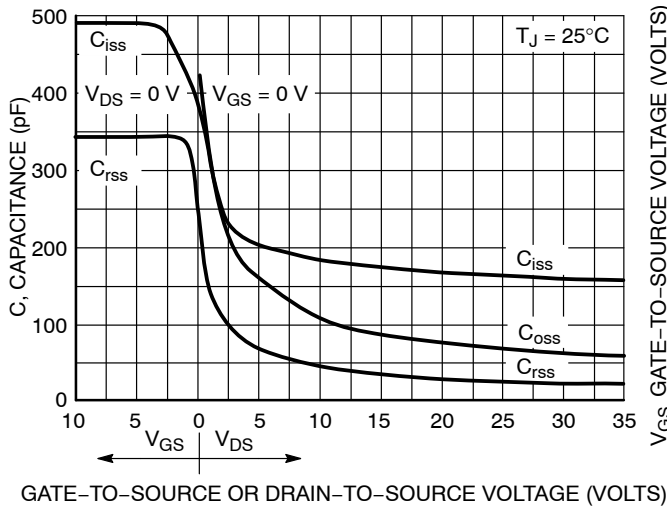

Figure 11. Capacitance Variation

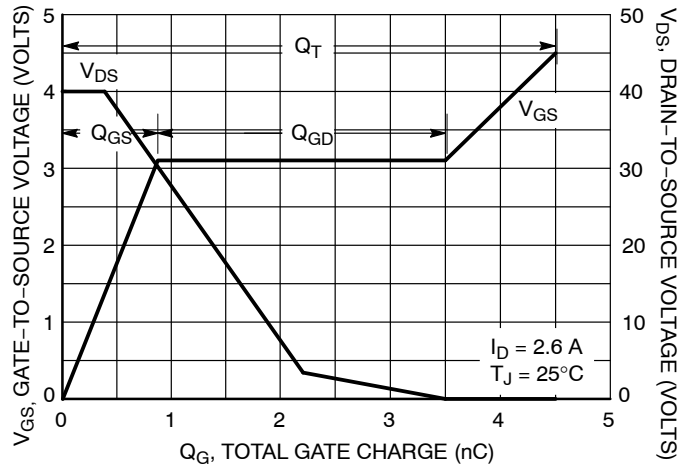

Figure 12. Gate-to-Source Voltage vs. Total Gate Charge

TYPICAL PERFORMANCE CURVES

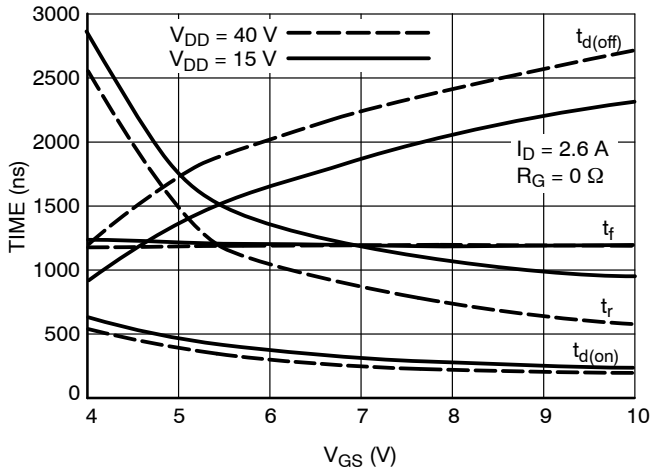

Figure 13. Resistive Load Switching Time vs. Gate-Source Voltage

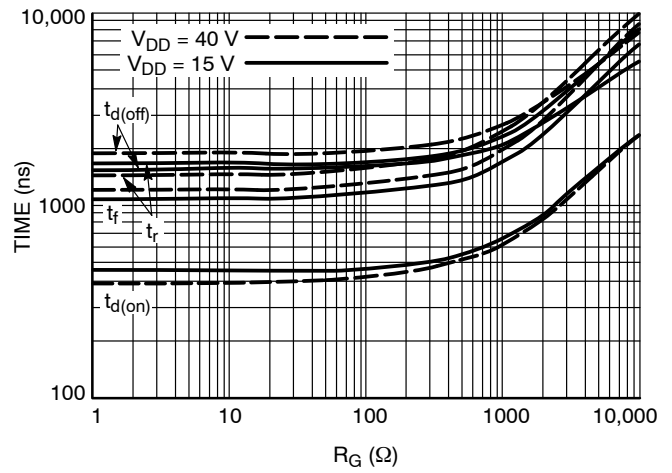

Figure 14. Resistive Load Switching Time vs. Gate Resistance ( $V_{GS} = 5\text{ V}$ ,  $I_D = 2.6\text{ A}$ )

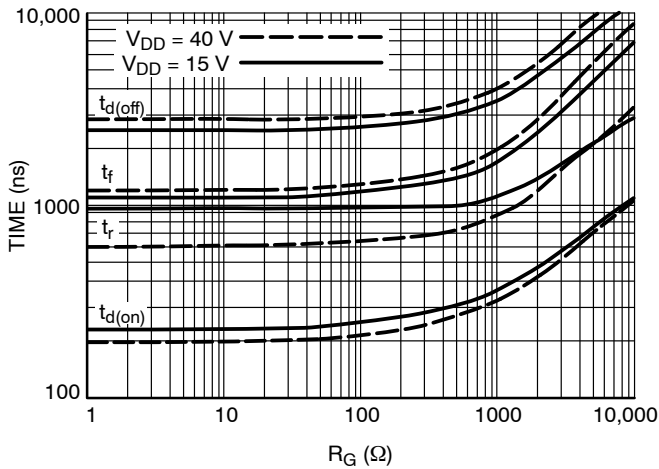

Figure 15. Resistive Load Switching Time vs. Gate Resistance ( $V_{GS} = 10\text{ V}$ ,  $I_D = 2.6\text{ A}$ )

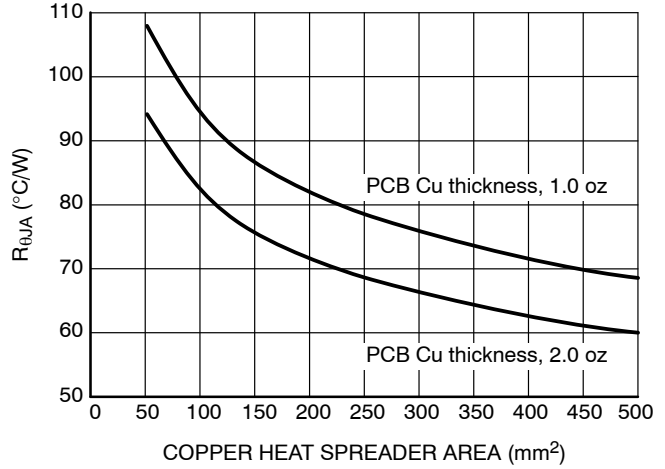

Figure 16.  $R_{\theta JA}$  vs. Copper Area

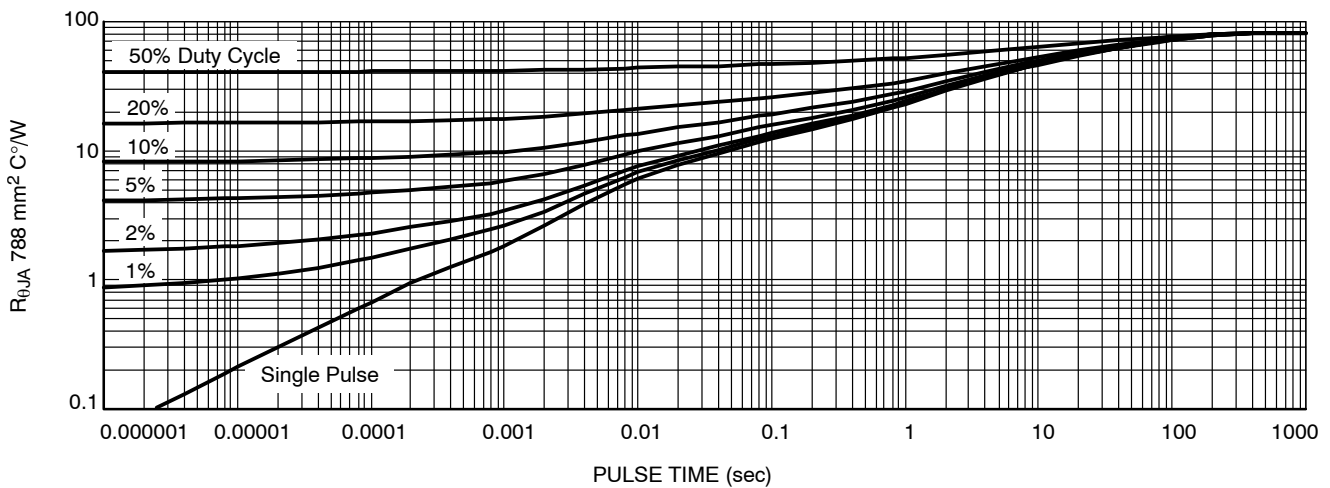
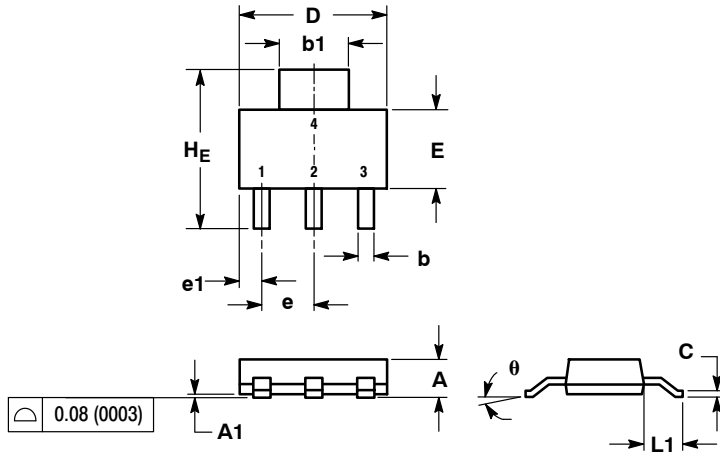

Figure 17. Transient Thermal Resistance

# NCV8440

## PACKAGE DIMENSIONS

SOT-223 (TO-261)  
CASE 318E-04  
ISSUE L



- NOTES:  
1. DIMENSIONING AND TOLERANCING PER ANSI Y14.5M, 1982.  
2. CONTROLLING DIMENSION: INCH.

DIM	MILLIMETERS			INCHES		
	MIN	NOM	MAX	MIN	NOM	MAX
A	1.50	1.63	1.75	0.060	0.064	0.068
A1	0.02	0.06	0.10	0.001	0.002	0.004
b	0.60	0.75	0.89	0.024	0.030	0.035
b1	2.90	3.06	3.20	0.115	0.121	0.126
c	0.24	0.29	0.35	0.009	0.012	0.014
D	6.30	6.50	6.70	0.249	0.256	0.263
E	3.30	3.50	3.70	0.130	0.138	0.145
e	2.20	2.30	2.40	0.087	0.091	0.094
e1	0.85	0.94	1.05	0.033	0.037	0.041
L1	1.50	1.75	2.00	0.060	0.069	0.078
H	6.70	7.00	7.30	0.264	0.276	0.287
θ	0°	-	10°	0°	-	10°

- STYLE 3:  
PIN 1. GATE  
2. DRAIN  
3. SOURCE  
4. DRAIN

### SOLDERING FOOTPRINT\*

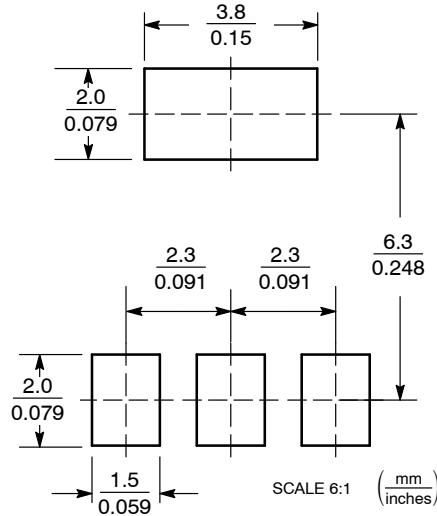

\*For additional information on our Pb-Free strategy and soldering details, please download the ON Semiconductor Soldering and Mounting Techniques Reference Manual, SOLDERRM/D.

ON Semiconductor and are registered trademarks of Semiconductor Components Industries, LLC (SCILLC). SCILLC reserves the right to make changes without further notice to any products herein. SCILLC makes no warranty, representation or guarantee regarding the suitability of its products for any particular purpose, nor does SCILLC assume any liability arising out of the application or use of any product or circuit, and specifically disclaims any and all liability, including without limitation special, consequential or incidental damages. "Typical" parameters which may be provided in SCILLC data sheets and/or specifications can and do vary in different applications and actual performance may vary over time. All operating parameters, including "Typicals" must be validated for each customer application by customer's technical experts. SCILLC does not convey any license under its patent rights nor the rights of others. SCILLC products are not designed, intended, or authorized for use as components in systems intended for surgical implant into the body, or other applications intended to support or sustain life, or for any other application in which the failure of the SCILLC product could create a situation where personal injury or death may occur. Should Buyer purchase or use SCILLC products for any such unintended or unauthorized application, Buyer shall indemnify and hold SCILLC and its officers, employees, subsidiaries, affiliates, and distributors harmless against all claims, costs, damages, and expenses, and reasonable attorney fees arising out of, directly or indirectly, any claim of personal injury or death associated with such unintended or unauthorized use, even if such claim alleges that SCILLC was negligent regarding the design or manufacture of the part. SCILLC is an Equal Opportunity/Affirmative Action Employer. This literature is subject to all applicable copyright laws and is not for resale in any manner.

### PUBLICATION ORDERING INFORMATION

LITERATURE FULFILLMENT:  
Literature Distribution Center for ON Semiconductor  
P.O. Box 5163, Denver, Colorado 80217 USA  
Phone: 303-675-2175 or 800-344-3860 Toll Free USA/Canada  
Fax: 303-675-2176 or 800-344-3867 Toll Free USA/Canada  
Email: orderlit@onsemi.com

N. American Technical Support: 800-282-9855 Toll Free  
USA/Canada  
Europe, Middle East and Africa Technical Support:  
Phone: 421 33 790 2910  
Japan Customer Focus Center  
Phone: 81-3-5773-3850

ON Semiconductor Website: [www.onsemi.com](http://www.onsemi.com)  
Order Literature: <http://www.onsemi.com/orderlit>  
For additional information, please contact your local Sales Representative